



PV200/210

Operating Instructions



Bracken Hill
South West Industrial Estate
Peterlee
Co Durham
SR8 2SW
ENGLAND
Tel: +44(0)191 5863511
www.seaward.co.uk
sales@seaward.co.uk
service@seaward.co.uk

Part Number 389A559 Revision 3
September 2017
© 2017 Seaward Electronic

Limited Warranty & Limitation of Liability

SEAWARD Electronic Limited guarantees this product to be free from defects in material and workmanship under normal use and service for a period of 2 year, provided the instrument is serviced and calibrated by authorised agent in accordance with the manufactures instructions. The period of warranty will be effective at the day of delivery.

Manufacturer does not provide any warranty for the following:

- Any normal wear and tear;
- Errors or damage caused by: (i) misuse or not using your product in accordance with the user guide, such as if the product has been exposed to moisture, to dampness or to extreme thermal or environmental conditions or to rapid changes in such conditions, to corrosion, to oxidation, to spillage of food or liquid or to influence from chemical products, (ii) using your product with, or connecting it to, any product, accessory, software, or service not manufactured or supplied by the manufacturer, (iii) any products combined with your product by a third party, (iv) damage or errors caused by hacking, cracking, viruses, or other malware, or by unauthorised access to services, accounts, computer systems or networks; or (v) other acts beyond the manufacturer's reasonable control.

This Warranty is not valid:

- If your product, or the software it runs on, has been (i) opened, modified, or repaired without the manufacturer's authorisation, or (ii) repaired with unauthorised spare parts;
- If you have not installed the latest software updates that are publicly available for your product within a reasonable time of their release; or
- If you refuse to give possession of the product to the manufacturer for repair and investigation.

(c) Copyright 2017

All rights reserved. Nothing from this edition may be multiplied, or made public in any form or manner, either electronically, mechanically, by photocopying, recording, or in any manner, without prior written consent from SEAWARD Electronic Limited. This also applies to accompanying drawings and diagrams.

Due to a policy of continuous development SEAWARD Electronic Limited reserves the right to alter the equipment specification and description outlined in this publication without prior notice and no part of this publication shall be deemed to be part of any contract for the equipment unless specifically referred to as an inclusion within such contract.

Table of Contents

Limited Warranty & Limitation of Liability.....	2
Table of Contents.....	3
Introduction.....	4
1 User Notes.....	4
2 Safety Notes.....	4
3 Accessories.....	6
3.1 Standard Contents.....	6
3.2 Optional Accessories.....	6
4 Unit Description.....	7
4.1 Identifying parts of the unit.....	7
4.2 LCD display.....	8
5 Using the Seaward PV200/210.....	9
5.1 Powering On the PV200/210.....	9
5.2 Battery Condition Check.....	9
5.3 Setting the date and time.....	9
5.4 Protective Earth Resistance (Rpe) Function.....	9
5.4.1 Test lead resistance null.....	9
5.4.2 Resistance Measurement.....	10
5.5 Voltage Measurement.....	11
5.6 Point to Point Insulation Resistance (Riso) Function.....	11
5.7 Auto Sequence Measurement.....	12
5.7.1 Selecting Automatic Test Sequence.....	12
5.7.2 Automatic Sequence.....	14
5.7.3 Displaying the I-V Curve after the test sequence.....	15
5.8 Memory Store.....	16
5.9 Memory Recall.....	17
5.10 Memory Clear.....	17
5.11 Operating Current.....	17
5.12 Auto Shutdown.....	18
5.13 Error Messages.....	18
5.13.1 User serviceable error codes.....	18
5.13.2 Non user serviceable error codes.....	19
5.13.3 Overriding the HiSC error code.....	19
6 Use with the Solar Survey 200R.....	20
6.1 Pairing with the Survey 200R.....	20
6.2 Un-Pairing from the Survey 200R.....	20
6.3 Put the Survey 200R into transmit mode.....	20
6.4 Normal operation.....	20
6.5 Downloading data to PC.....	21
7 Electrical Specifications.....	21
7.1 Open Circuit Voltage Measurement (PV Terminals).....	21
7.2 Short Circuit Current Measurement.....	21
7.3 Earth Continuity.....	21
7.4 Insulation Resistance (Auto Test Sequence).....	21
7.5 Insulation Resistance.....	22
7.6 Rpe Voltage Measurement (4mm Terminals).....	22
7.7 Operating Current (via AC/DC Current Clamp).....	22
7.8 DC Power (via AC/DC Current Clamp).....	22
8 Environmental Conditions.....	22
9 Maintenance.....	23
9.1 Preparing to work on the Solar PV200/210.....	23
9.2 Securing the Solar PV200/210.....	23
9.3 Cleaning the Solar PV200/210.....	23
9.4 Battery Replacement.....	23
9.5 Replacing the Fuse.....	24
9.6 Service and Calibration.....	25
9.7 Spare Parts.....	25
Appendix A.....	26

Introduction

The Seaward PV200/210 is a hand held, battery powered, multi-function solar photovoltaic installation test instrument capable of performing all of the electrical tests required by IEC 62446, including:

Earth continuity @ 200mA

AC / DC voltage using the 4mm terminals

Open circuit module, string or array voltage

Voltage polarity

Short circuit module, string or array current

Module, string or array insulation resistance at 250V, 500V and 1000V

Probe to probe insulation resistance at 250V, 500V and 1000V

AC or DC Operating current

String I-V curve test

1 User Notes

This instrument and its operating instructions are intended for use by adequately trained personnel.

The following symbols are used in these operating instructions and on the Seaward PV200/210.



Warning of electrical danger!

Indicates instructions must be followed to avoid danger to persons.



Important, follow the documentation! This symbol indicates that the operating instructions must be adhered to in order to avoid danger.

2 Safety Notes

In order to ensure safe operation of this instrument, all notes and warnings in these instructions must be observed at all times.



All test leads must be securely attached to the PV system under test. Always use the solar PV connectors supplied or alligator clips to connect test leads to the PV system under test. Test probes must not be used without alligator clips.



Never disconnect the test leads whilst any measurement is active. This may result in electrical arcing and may damage the PV200/210.



The PV200/210 is intended for use in a dry environment only.



The PV200/210 RED and BLACK 4mm test terminals may be used to make measurements on circuits rated up to CAT III 300 V AC/DC with reference to earth. Do not connect the PV200/210 to voltages which may exceed this rating.



The PV test terminals maximum rating: 1000V DC open circuit voltage, 15A short circuit current, 10kW DC power. Do not exceed this rating. The DC supply must be isolated from earth/ground during testing.



High voltages are present at the probe tips of the PV200/210 during insulation resistance measurement. Always hold test probes behind the hand guards.



Check the PV200/210 and all associated cables and leads before operating the equipment. Do not use if there are signs of damage. Only use the test leads supplied with the PV200/210.



Do not touch any exposed metal parts of the solar PV installation during testing.



Always ensure that the circuit under test is electrically isolated from the mains supply before attempting an earth resistance or insulation resistance measurement.



Do not leave the PV200/210 permanently connected to a PV installation. Always disconnect all test leads immediately after use.



Do not attempt to turn off the PV200/210 while tests are active.

Where safe operation of the PV200/210 is no longer possible it should be immediately shut down and secured to prevent accidental operation.

It must be assumed that safe operation is no longer possible:

- if the instrument or leads show visible signs of damage or
- the instrument does not function or
- after long periods of storage under adverse environmental conditions.



If the PV200/210 is being used to determine the presence or absence of hazardous voltages, always prove the operation of voltage measurement function before and after use by means of a known voltage source or proving unit.



The PV200/210 is not intended for continuous use. When the PV200/210 is not being used disconnect it from the system under test.



If the PV200/210 is used in a manner not specified by this document then the protection provided by the equipment may be impaired.



Do not open unit, no user serviceable parts.

3 Accessories

3.1 Standard Contents

The Seaward PV200/210 test kit is supplied with the following items:

- 1 off PV200/210 unit
- 1 off professional carry case
- 1 set 1.2m red and black test lead with test probe and alligator clip
- 1 set MC4 PV test lead adaptors
- 1 off Quick Reference Guide
- 6 off MN1500 (AA) 1.5v Batteries
- 1 off AC/DC current clamp adapter

3.2 Optional Accessories

Description	Part number
SolarCert Elements V2 software license card	389A950
Solar Survey 200R 433Mhz European version (including suction mount temperature sensor)	396A914
Solar Survey 200R 915Mhz US version (including suction mount temperature sensor)	396A916
Solar Survey 200R quick release mounting bracket	396A979
Solar Survey 200R suction mount temperature sensor	396A980
Sunclix PV test lead adaptors	396A960
Combiner box test lead set – converts MC4 PV test leads to 4mm test probe/alligator clip	388A953
Solar Power Clamp - 1000V ac/dc, 600A ac/dc, 600kW ac/dc	396A955
Replacement 500mA FA 1000V Fuse	27B137

4 Unit Description

4.1 Identifying parts of the unit

The numbering below refers to figure 1 and figure 2.

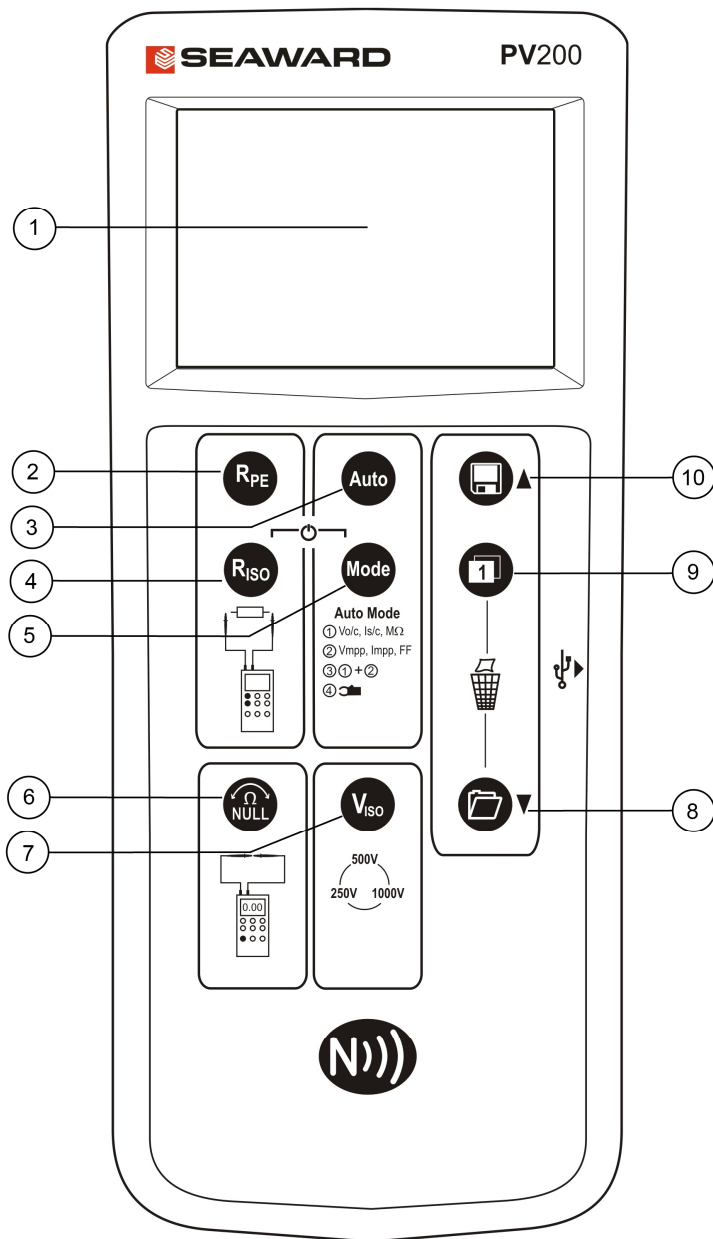

Figure 2 PV200/210 Front view

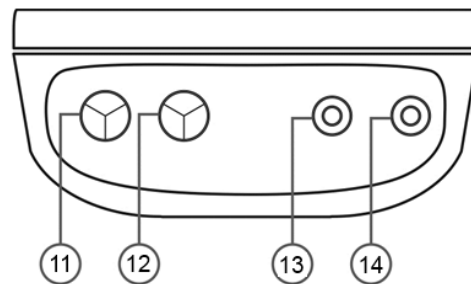

Figure 1 PV200/210 End view

1. LCD Display
2. Rpe test key
3. Auto test sequence key
4. Point to Point Insulation test.
5. Auto Mode select key
6. Test lead resistance null key
7. Insulation test voltage select key
8. Memory recall key
9. LCD Switch key
10. Memory store key
11. +ve PV test lead input (RED)
12. -ve PV test lead input (BLACK)
13. -ve 4mm test lead input (BLACK)
14. +ve 4mm test lead input (RED)

4.2 LCD display

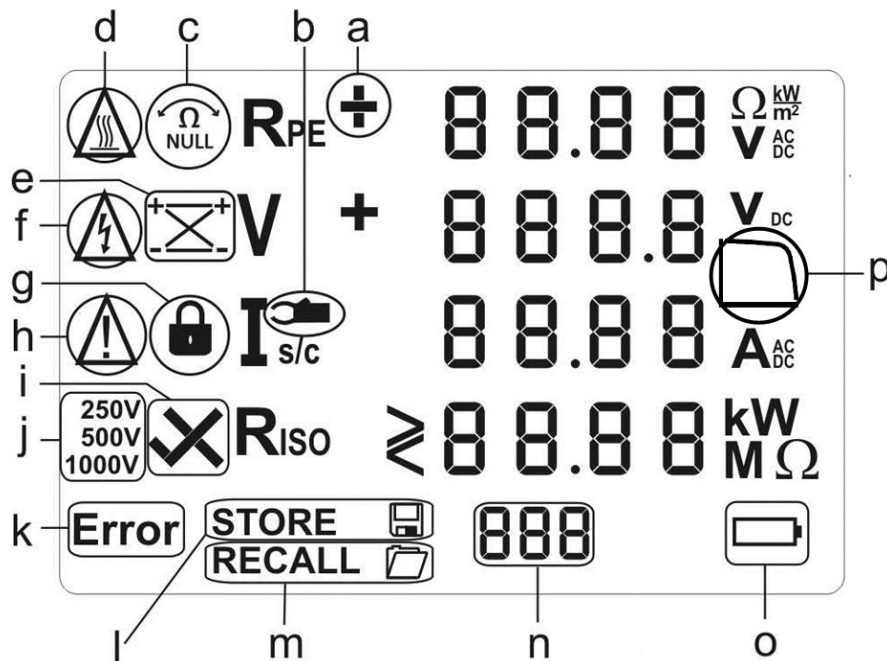





Figure 3 LCD display icons

- a. Rpe voltage polarity. For AC voltages alternating + and – is shown.
- b. Current clamp measurement active.
- c. Rpe Null offset - indicates that test lead resistance offset is active.
- d. Caution – hot surface. If this icon appears, the PV200/210 must be disconnected immediately from the PV system until the icon is no longer shown on the LCD.
- e. Solar module polarity indicator – indicates the polarity of the DC voltage applied to the PV test terminals e.g. correct or reversed
- f. Caution – hazardous voltage detected.
- g. Rpe test lock – active when continuous Rpe measurement has been enabled.
- h. Caution – refer to operating instruction. When this icon is active, the operating instructions must be followed to avoid risk of danger.
- i. Riso PASS/FAIL – indicates whether the measured insulation resistance is above or below the factory set acceptable value.
- j. Insulation Test Voltage selection – indicates the test voltage selected for insulation resistance measurements.
- k. Error – Refer to the specific error codes for further details.
- l. STORE - indicates that you can now store the test result shown on the display or that the test result is being stored.
- m. RECALL – the data shown on the LCD has been recalled from the on-board memory.
- n. User Memory display – indicates the memory location of the results stored or recalled on the LCD.
- o. Battery status icon.
- p. I-V status icon / low fill factor indicator

5 Using the Seaward PV200/210

5.1 Powering On the PV200/210







To turn the PV200/210 on, press and hold the Riso  and Mode  keys simultaneously. To turn the PV200/210 off, press and hold the Riso  and Mode  keys simultaneously.

5.2 Battery Condition Check

The PV200/210 automatically performs battery condition checks whilst idle and during measurements. When the battery level is low, the battery symbol icon will appear on the PV200/210 display. The PV200/210 will continue to function, however the batteries should be replaced.

Note: When the battery symbol icon is flashing all tests will be inhibited and the batteries must be replaced immediately as described in section 9.4.

5.3 Setting the date and time

1. Turn off the PV200/210.
2. Press and hold the  key and then press simultaneously the  key and the  key.
3. The date format and time format is shown as follows:
MM.DD = month (1-12). Day (1-31)
YYYY = year
HH.mm = hours (0-23).minutes (0-59)
SS = seconds (0-59)
4. Use the  key to navigate to the field that you wish to change.
5. A flashing field shows that this field can be set.
6. Use the  key and the  key, to increase or decrease the value. With each change, the seconds field is set to zero.
7. Turn off the device to save the setting.

Note: If the PV200/210 has established a Solarlink™ connection to the Survey 200R, the date/ time of the PV200/210 will automatically be synchronized to the date/ time of the Survey 200R. The Survey 200R real-time clock is the master and the PV 200/210 the slave.

5.4 Protective Earth Resistance (Rpe) Function



Always ensure that the circuit under test is electrically isolated.





If the test probes are connected to a voltage >30V AC/DC the measured voltage will be displayed on the LCD, the Rpe measurement function will be disabled.

5.4.1 Test lead resistance null

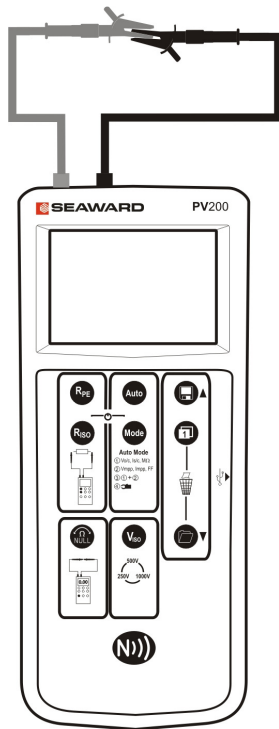
The PV200/210 can automatically compensate for the resistance of the test leads using the following procedure:



1. Hold the tips of the test probes firmly together as shown, ensure a good electrical connection.
2. Press and hold the Rpe Null  key (6).
3. The measured resistance of the test leads is shown in the primary display until a beep is heard.
4. The Rpe display will now 0.00 and the Null icon is illuminated on the display.
5. All subsequent measurements will take into account the test lead resistance compensation until the function is disabled by pressing the Rpe Null  key (6) again.

Note: A maximum test lead resistance of 10Ω ohms can be taken into account. If the test lead resistance is greater than 10Ω an error beep will indicate that the lead Zero function has failed.

Note: For ease of use, the PV200/210 will store the lead compensation when switched off and recall this value when next switched on. The stored value is only applicable to the test leads used when the compensation measurement was made. If the test leads are replaced the Rpe null function should be repeated using the replacement test leads.

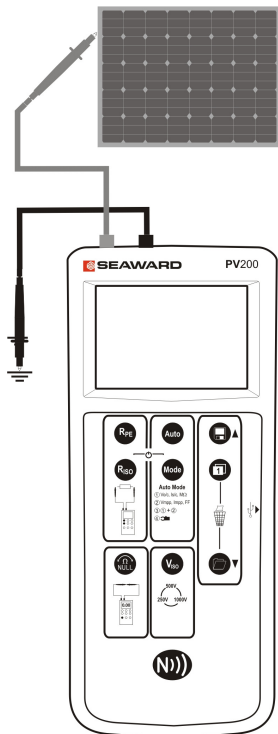

5.4.2 Resistance Measurement



To make a single measurement:

1. Connect the red and black test leads as shown.
2. Press the Rpe key .
3. The resistance between the test probes is displayed.

To make a continuous measurement:

1. Connect the red and black test leads as shown.
2. Press and hold the Rpe key  until the lock icon appears on the display.
3. The resistance between the test probes is displayed.
4. Press the Rpe key  to terminate the continuous measurement mode.

Note: Do not connect the PV200/210 to a voltage source while performing the resistance measurement as this will blow the fuse located in the battery compartment.

Note: The continuity measurement is not stored in memory with the automatic test sequence. Continuity measurements are stored as individual records that only record the continuity measurement.

5.5 Voltage Measurement

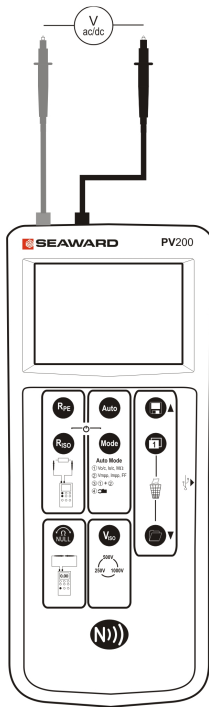

1. Connect the red and black test probes to a voltage source
2. The PV200/210 will automatically measure the voltage between the probes.
3. The polarity of the voltage is shown using the icon to the left of the displayed voltage.
4. AC voltages are indicated by alternating + and - symbols.

5.6 Point to Point Insulation Resistance (Riso) Function



Always ensure that the circuit under test is electrically isolated.



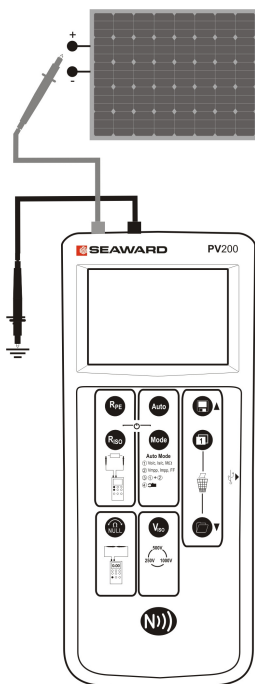

If the test probes are connected to a voltage $>30V$, the measured voltage will be displayed on the LCD and the Riso measurement function is inhibited.



To make a single measurement:

1. Connect the red and black test leads as shown.
2. Select the required test voltage using the Viso key.
3. Press the Riso key.
4. The resistance between the test probes is displayed.

To make a continuous measurement:

1. Connect the red and black test leads as shown.
2. Select the required test voltage using the Viso key .
3. Press and hold the Riso key  until the lock icon appears on the LCD.
4. The resistance between the test probes is displayed.
5. Press the Riso key  to terminate the continuous measurement mode.

Note: Do not connect the PV200/210 to a voltage source while performing the resistance measurement as this will blow the fuse located in

the battery compartment.

Note: The Point to Point Insulation measurement cannot be stored in memory with the as part of an automatic test sequence record. Point to Point insulation measurements are stored as individual records that only record the insulation measurement.

5.7 Auto Sequence Measurement



All test leads must be securely attached to the PV system under test. Always use the solar PV connectors supplied or alligator clips to connect test leads to the PV system under test. In order to reduce the risk of electrical arcing, test probes without alligator clips should not be used.



Never disconnect the test leads whilst any measurement is active. This may result in electrical arcing and may damage the PV200/210.



Always ensure that the circuit under test is electrically isolated from any mains supply.



Do not attempt to turn off the PV200/210 while tests are active.



Due to the high input impedance of the red 4mm test terminal, voltage present on the array framework due to leakage current through the PV system insulation may be shown on the display before an automatic test sequence is started.

5.7.1 Selecting Automatic Test Sequence

The Viso key is used to select either the 250V, 500V or 1000V insulation test voltage, **please refer to relevant standards for testing requirements.**

The Mode key is used to select the required auto test sequence from the table shown below.

Mode	Measurements
1	Vo/c, Is/c, Riso
2	I-V curve, Vo/c, Is/c, Vmpp, Impp, FF
3	I-V curve, Vo/c, Is/c, Vmpp, Impp, FF, Riso
4	Operating current. Operating voltage and power*

*Measurement of operating voltage and power requires 'Y' splitters to allow both the PV 200/210 and inverter to be connected to the PV string.

Press and release the Mode key to show the currently selected test mode. When Mode is shown on the display the Mode key can be used to cycle through the available test modes.

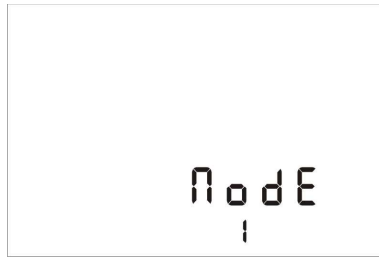

If the **Riso** icon is displayed then an insulation test will be performed as part of the automatic test sequence.

If the I-V curve icon  is displayed then an I-V curve will be performed as part of the automatic test sequence.

Mode 1

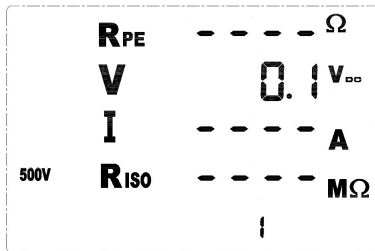

Riso - - - - MΩ

This mode will perform;

- V o/c
- I s/c
- Insulation MΩ

Mode 2

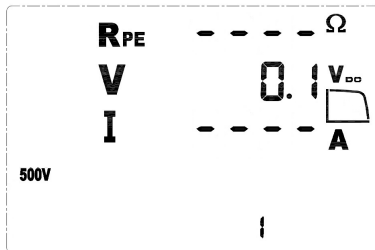

I-V icon displayed

This mode will perform;

- V o/c
- I s/c
- I-V Curve

Mode 3

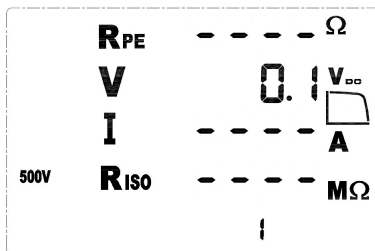

Riso - - - - MΩ and I-V icon displayed

This mode will perform;

- V o/c
- I s/c
- Insulation MΩ
- I-V Curve

The Mode key is also used to select the Operating Current Mode. See section 5.11.

5.7.2 Automatic Sequence

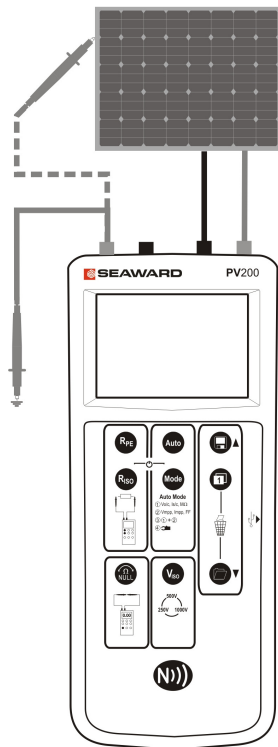



1. Connect the PV200/210 securely to the PV module as shown using the supplied test lead adaptors or test probes with alligator clips. Never use test probes without alligator clips as this may result in arcing.

Never remove any connection to the PV module when any test is active.

2. The red test probe must be connected to earth when measuring insulation resistance in a Mode 1 or Mode 3 sequence. Where the structure/frame is bonded to earth, the earth connection maybe to any suitable earth or to the array frame. Where the array frame is not bonded to earth, a commissioning engineer may choose to do two tests:

- a. Between array cables and earth
- b. Between array cables and frame

3. The PV200/210 will automatically detect any DC voltage connected to the PV test socket inputs 8 and 9 and display the measured voltage.
4. If the PV voltage polarity is reversed, the polarity indicator will flash a cross icon next to the voltage icon.
5. If the incoming voltage is >30v then the shock hazard icon will flash.
6. Press the Auto key and the Solar PV200/210 will automatically perform the following the selected test sequence.
7. If an I-V curve measurement has been selected, progress is shown by moving dashes in the Is/c display field.
8. When an I-V curve measurement is complete, the measured values for Vo/c and Is/c will appear on the display.
9. If the fill factor is ≥ 60 the  icon is displayed
10. If the fill factor is <60 the  icon is displayed to indicate that a problem may exist with the PV module or system under test. The measured I-V curve can be examined in detail on-site using the PVMobile App.
11. The measurement results will remain on the LCD for 20 seconds or until a key is pressed.
12. If the insulation test has been performed then a tick or cross will be displayed next to the measurement indicating whether the result is above or below the threshold values shown in the table below.

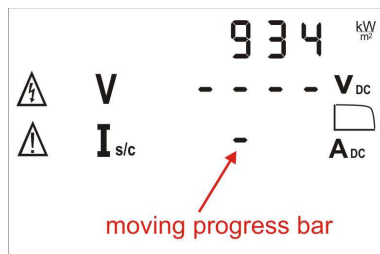

IV test in progress

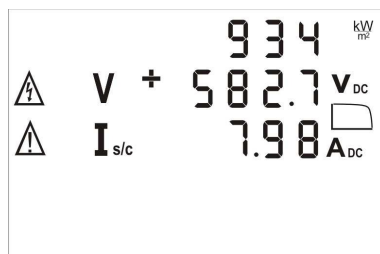

IV test complete

Viso	Pass / Fail Limit
250v	0.5 M ohms
500v	1.0 M ohms
1000v	1.0 M ohms

13. If the selected test sequence includes an I-V curve, the I-V curve icon will flash. Once the test is complete the I-V curve icon will become static displaying whether the curve was good or bad. The LCD switch key can be used to view the Irradiance, MPP V, MPP I and Fill Factor.

Note: *The PV200/210 checks the validity of each voltage and current sample taken during the I-V curve measurement to reduce errors caused by factors such as changes in irradiance.*

The I-V curve measurement time will depend on the stability of the voltage and current during the measurement period. Factors such as transient changes in irradiance will extend the measurement time.

Note: *During the insulation test, the PV200/210 applies a short circuit across the PV string. The insulation test voltage is then applied between the RED 4mm test lead and the two PV test terminals.*

Note: *If the DC voltage polarity is incorrect or the voltage is <5V or >1000V the Auto Test will be disabled until the problem is corrected.*

Note: *The Continuity measurements are not stored in memory with the Automatic test sequence.*

5.7.3 Displaying the I-V Curve after the test sequence

In order to display I-V curves you must have an NFC enabled Android device running the PV Mobile App which is available from the Android Play store.

The PV200/210 includes the ability to transfer I-V curves to an Android device running the PV Mobile App using NFC.

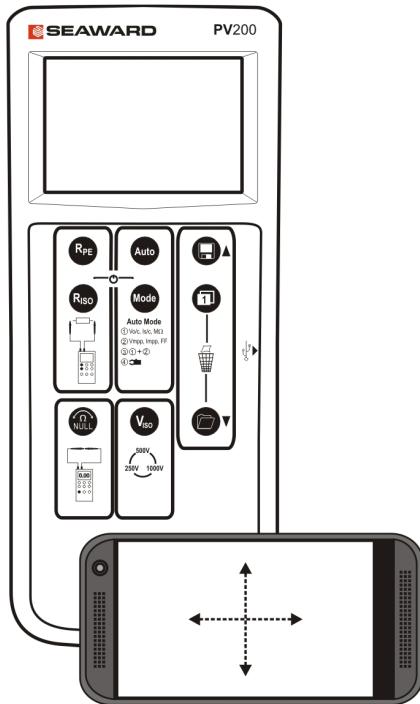

1. When the I-V curve test is complete, or when reviewing stored curve data, the I-V curve will be copied in to the on-board NFC device. While this is happening **NFC** will be displayed at the bottom of the LCD.
2. When reviewing I-V curve data stored in the PV200/210 memory, use the display toggle key  to change the display to show the Mpp values and FF as shown below before attempting the NFC transfer.
3. **Check the instructions for your Android device to determine the position of the NFC antenna.**
4. Place your Android device running the PV Mobile App on the front surface of the PV200/210 such that the NFC antenna in the Android device is positioned over the NFC logo on the front of the PV200/210.
5. The I-V curve will be copied and displayed in the PV Mobile App.

Note: Do not place you Android device over the NFC logo while “NFC” shown on the PV200/210 display as this may interrupt or inhibit the data transfer to the NFC device.

Note: Results of test sequence that do not include I-V curves will not be copied to the NFC device.

5.8 Memory Store

The Solar PV200/210 can store up to 999 complete sets of measurements. The number of records currently held in memory is shown on the bottom of the display i.e. if the display shows 16 there are 16 records in memory and the next result will be stored in location 17.

STORE



The current test is complete. The PV200/210 is asking whether the current test results should be stored.

Press the Memory Store key  to store all measured values on the display. If there is memory space available the Store icon will appear, and the readings will be stored in the memory.

STORE



The current test results are being stored into the memory location 10 as indicated on the LCD.

If the memory is full, the buzzer will sound and the results will not be stored.

If there are no valid readings on the display when the store key is pressed, the buzzer will beep, the Store icon will flash and nothing will be stored.

Note: After the results are stored to memory they are read back to ensure that the data is correct. If the read data is different from what was written then a READ FAIL warning will be displayed. Pressing a button will return you to the test results where the Store can be performed again. Should this happen the first set of data will still be recorded and take up a memory location. When reviewed or downloaded the corrupted record will be tagged as corrupt.

5.9 Memory Recall

Each successive press of the Recall key will increment the user memory location indicator and display the measured values stored in that memory location. The location number is shown on the bottom of the LCD display. After the first press of Recall, the Store key can be used to decrement the user memory location indicator to recall previous memory location.

If a memory location holds an I-V Curve result, the I-V curve icon will be displayed on the LCD. The display toggle key  can be used to switch between the two sets of I-V curve result data. When the I-V curve results are displayed on the LCD the I-V curve data will be copied to the NFC device and **NFC** will be displayed at the bottom of the LCD for the duration of the copy. The curve can be viewed using an NFC enabled Android device running the PV Mobile App. See section 5.7.3.

Note: If the recalled results are corrupt then the measurement will still be displayed but the warning triangle will flash results are being displayed.

Note: Do not place you phone over the NFC logo while the I-V curve icon is flashing as this may slow down or inhibit the copy to the NFC device.

Note: Results of test sequence that do not include I-V curves will not be copied to the NFC device.

Press and hold the Recall key while in Recall mode to download data to a PC via the USB port.

5.10 Memory Clear

While in Recall mode press the LCD Switch and Save keys together to clear all the user memory locations. The LCD will display **CLr** and count down from 5, when the counter reaches zero the memory will be erased. If the keys are released before the counter reaches zero then the memory will not be erased.

5.11 Operating Current

The PV200/210 can be used to measure the DC operating current of a solar PV installation as shown.

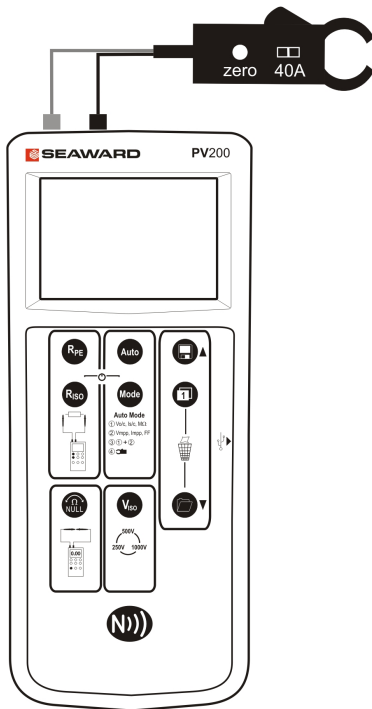

1. Disconnect all cables from the PV test inputs (8 & 9 in figure 2).
2. Connect the current clamp to the red – black 4mm probe inputs.
3. Move the current clamp switch to the 40A position.
4. Press the zero key on the current clamp for a few seconds.
5. Place the clamp around the DC cable of the solar installation.
6. Press the Viso key until the clamp icon (figure 3, icon b) appears on the LCD.
7. The measured current is shown on the LCD next to the clamp icon.

Note: *The Auto key is disabled whilst the DC power measurement is in use.*

5.12 Auto Shutdown

After 1 minute of being idle the PV200/210 will turn itself off in order to conserve battery power. This auto shutdown period can be extended as follows:



1. Turn the PV200/210 unit off
2. Press and hold the NULL key, then press both the ON/OFF keys together. Keep holding the NULL key.
3. The display will show “OFF” on line 1, and the turnoff time on line 2 (in minutes)
4. Keep holding the NULL key and press the Viso key. Each press of the Viso key will increment the turnoff time.
5. Increment beyond 10 to set the time back to 1 minute

Note: *When displaying DC Operating Power (section 5.11) the Auto Shutdown function is deactivated whilst DC voltage or current are detected. This will allow extended time for monitoring DC power.*

5.13 Error Messages

Under certain conditions, the PV200/210 may indicate an error message.

5.13.1 User serviceable error codes

Error message	Remedy
FUSE	The internal fuse has blown. Refer to section 8.5 in the operating instructions for details on how to replace the fuse.
HOT	The electronics within the PV200/210 have reached the maximum safe temperature. This can occur after repeated short circuit current measurements at high current levels. Allow the unit to cool down before further use.
HISC	The DC short circuit current has exceeded the maximum rated value of 15A. The measurement sequence has been aborted. Reference section 5.13.3.
HOC	High Open Circuit Voltage (ie > 1000V), check supply voltage, if above 1000V cease testing.
> 10.00 kW	During the Automatic test sequence the PV200/210 has calculated that the maximum power rating has been exceeded. Insulation tests and I-V Curves will not be performed until the power measurement is less than 10kW.
FAIL STORE 	The memory store verification check has failed, the stored record will be logged as corrupt. Please store the result again. Please note that this will store the record in the next available memory location.
NFC FAIL STORE 	The NFC memory store verification check has failed, the record in NFC is incomplete or corrupt. Ensure that no NFC enabled device is near the PV200/210 NFC antenna. Saved data can be reviewed by using the memory recall function.

5.13.2 Non user serviceable error codes

Error message	Remedy
CAL	The PV200/210 is not correctly calibrated. Return the unit to an authorised Service Agent.
Er 1,2 etc	Return the unit to an authorised Service Agent.
HOLF	Return the unit to an authorised Service Agent.
FET	Return the unit to an authorised Service Agent.
rL 1,2,3 or 4	Return the unit to an authorised Service Agent.

5.13.3 Overriding the HiSC error code

The HiSC error code is displayed if a current of >15A is measured at the beginning of the test. If this error code is displayed then ensure that the connections made to the PV200/210 cannot generate >15A. Once you have confirmed that it is okay to proceed the HiSC warning can be overridden. To override the HiSC warning press the AUTO key, this will start a new test and display the HiSC error code, while this is displayed press and hold the NULL key then press and hold the AUTO key while the NULL is still being pressed, the selected AUTO test will start with the pre-test disabled.

6 Use with the Solar Survey 200R

6.1 Pairing with the Survey 200R

Make sure there are no other units operating nearby.

Turn off both the PV200/210 and Survey 200R unit.

On the Survey 200R, press and hold the On/Off keys, keep both keys pressed.

On the PV200/210, press and hold the Riso and Mode keys, keep both keys pressed.

The Survey 200R will now send its “Pairing” signal. When the PV200/210 detects this signal, it will remember the serial number of the Survey 200R, and will look for that particular serial number in all future communications.

When the PV200/210 has successfully paired, it will beep and display the serial number of the Survey 200R. This should normally happen within a couple of seconds.

Note: The top line of the PV200/210 display will now show the W/m² icon.

6.2 Un-Pairing from the Survey 200R

Make sure there are no other units operating nearby.

Turn the PV200/210 off.

On the PV200/210, press and hold the Riso and Mode keys, keep both keys pressed for about 10 seconds. The PV200/210 will then beep and clear its screen. The unit is now no longer paired to any Survey 200R. Note that the top line of the LCD will display Rpe ohms.

6.3 Put the Survey 200R into transmit mode

The Survey 200R can be put in and out of transmit mode by pressing and holding the temperature key, and then momentarily pressing the OK key.

When in transmit mode there will be a flashing icon above the temperature key.

Note: When in transmit mode the auto shut down feature is disabled. You must remember to turn the Survey 200R off in order to save battery power.

6.4 Normal operation

When the PV200/210 has been paired with a Survey 200R, the top line of the display is used to show the irradiance value measured by the Survey 200R.

The Survey 200R must be put into transmit mode as described above.

When the PV200/210 is in range of the Survey 200R it will display the Survey 200R irradiance value and display it on the top line of the LCD.

When an Auto test is performed, the PV200/210 captures the irradiance, ambient temperature and module temperature measurements from the Survey 200R. Press Store and all these values will be stored along with any measurements made using by the PV200/210.

6.5 Downloading data to PC

Connect the PV200/210 to PC using the USB cable. (This will create a COM port on the PC)

Run the Seaward Solar Datalogger application on the PC. Select the correct COM port. (Use the Help menu – Trouble shooting guide, to help finding the correct COM port)

Press the Recall key to put the PV200/210 into recall mode, press and hold the Recall key on the PV200/210 while in recall mode. After a few seconds the PV200/210 will transfer all its stored data to the PC.

By default the Datalogger application will save the data in CSV format. This can be opened using Solar Cert or Microsoft Excel. Note that each row of data will have the readings from the Survey 200R where possible.

7 Electrical Specifications

7.1 Open Circuit Voltage Measurement (PV Terminals)

Display Range	0.0VDC – 1000VDC
Measuring Range	5.0VDC – 1000VDC
Resolution	0.1VDC
Accuracy	±(0.5% + 2 digits)

7.2 Short Circuit Current Measurement

Display Range	0.00ADC – 15.00ADC
Measuring Range	0.50ADC – 15.00ADC
Maximum Power	10kW
Resolution	0.01 ADC
Accuracy	±(1% + 2 digits)

7.3 Earth Continuity

Test Voltage Open Circuit	>4V
Test Current into 2Ω	>200mA
Display Range	0.00Ω - 199Ω
Measuring Range (EN 61557-4)	0.05Ω –199Ω
Resolution	0.01Ω maximum
Accuracy	±(2% + 5 digits)
Repeat tests as per IEC61557-4	Approx 4000

7.4 Insulation Resistance (Auto Test Sequence)

Test Voltage Specification	-0% +20% (open circuit)
Test Voltage @ 1mA	>1mA into $U_N \times (1000\Omega/V)$
Test Current Short Circuit	<2mA
Display Range	0.05MΩ - 200MΩ
Measuring Range (EN 61557-2)	0.05MΩ – 200MΩ
Resolution	0.01MΩ maximum
Accuracy	0.05MΩ – 100MΩ ±(5% + 5 digits) 101MΩ – 200MΩ ±(10% + 5 digits)
Repeat tests as per IEC61557-2	Approx 4000

7.5 Insulation Resistance

Test Voltage Specification	-0% +20% (open circuit)
Test Voltage @ 1mA	>1mA into $U_N \times (1000\Omega/V)$
Test Current Short Circuit	<2mA
Display Range	0.05M Ω - 300M Ω
Measuring Range (EN 61557-2)	0.05M Ω – 300M Ω
Resolution	0.01M Ω maximum
Accuracy	$\pm(5\% + 5 \text{ digits})$
Repeat tests as per IEC61557-2	Approx 4000

7.6 Rpe Voltage Measurement (4mm Terminals)

Display Range	30V – 440V
Voltage Measuring Range	30V – 440V DC 30V – 440V AC 50-60Hz
Resolution	1V
Accuracy	$\pm(5\% + 2 \text{ digits})$

7.7 Operating Current (via AC/DC Current Clamp)

Display Range	0.1A – 40.0A
Current Measuring Range	0.1A – 40.0ADC 0.1A – 40.0AAC 50-60Hz
Resolution	0.1A
Accuracy	$\pm(5\% + 2 \text{ digits})$

7.8 DC Power (via AC/DC Current Clamp)

Display Range	0.00kW – 40kW
Measuring Range	0.50kW – 40kW
Resolution	0.01kW
Accuracy	$\pm(5\% + 5 \text{ digits})$

8 Environmental Conditions

The Solar PV200/210 has been designed to perform tests and measurements in a dry environment.

Maximum barometric elevation for making measurements is 2000M.

Overvoltage category IEC 60664/IEC 61010, 300V Category III (Red and Black 4mm terminals only).

Pollution degree 2 according to IEC 61010-1.

Protective system IP40 according to IEC 60529.

Electromagnetic compatibility (EMC). Interference immunity and emitted interference conforming to IEC 61326-1.

Operating temperature range of 0°C to 40°C, without moisture condensation.

The Solar PV200/210 can be stored at any temperature in the range -25°C to +65°C (relative humidity up to 90%). The batteries should be taken out of the instrument for storage.

Operating Altitude 0 to 2000 metres

9 Maintenance



Before removing the PV200/210 battery cover ensure that all test leads have been disconnected from the instrument. Electric shock danger!
Do not operate the PV200/210 without the battery cover securely in place.

9.1 Preparing to work on the Solar PV200/210.

Make sure the Solar PV200/210 leads and accessories are disconnected, before opening the instrument;

Power the unit off.

Disconnect all of the test leads from the unit

9.2 Securing the Solar PV200/210

Under certain conditions safe operation of the Solar PV200/210 can no longer be assumed:

Visible damage of the instrument case.

Incorrect measurement results.

Recognisable abuse to the instrument due to prolonged storage under improper conditions.

Recognisable abuse to the instrument due to extraordinary transportation stress.

Check the battery compartment for signs of battery electrolyte leakage.

In these cases, the PV200/210 should be immediately switched off, disconnected from any test or measurement function and secured to prevent any further use.

9.3 Cleaning the Solar PV200/210

Clean the external case of the Solar PV200/210 with a clean dry cloth.

Avoid using solvents and abrasive scouring agents to clean the external case of the Solar PV200/210.

Check the battery contacts and compartment are free of electrolytic contamination.

Any contamination of the battery contacts or compartment should be cleaned with a dry cloth.

9.4 Battery Replacement



Before opening the Solar PV200/210 ensure that it is disconnected from all voltage! Electric shock danger!

Power the unit off.

Disconnect all the test leads from the unit

Position the Solar PV200/210 face down and release the captive screw in the battery compartment cover.

Remove the battery compartment cover.

Remove the discharged batteries from the compartment.

Fit a new set of alkaline batteries.

Relocate the battery cover over the battery compartment and fasten in position with the battery cover captive screw.

9.5 Replacing the Fuse



Before opening the Solar PV200/210 ensure that it is disconnected from all voltages!
Electric shock danger!



All replacement fuse types are specified for ratings and size on the battery compartment cover on the rear of the Solar PV200/210.

Power the unit off.

Disconnect all the test leads from the unit.

Position the Solar PV200/210 face down and release the captive screw in the battery compartment cover.

Remove the battery compartment cover.

Lift one end of the fuse out of the fuse holder with the help of a flat bladed screwdriver.

Lift the defective fuse completely out of the fuse holder.

Insert a new fuse as described and specified by the text on the battery compartment cover.

Ensure that the new fuse is seated and centred in the fuse holder.

Relocate the battery cover over the battery compartment and fasten in position with the battery cover captive screw.

The Seaward PV200/210 panel circuit is protected by a 15A 1000V Solar fuse. This fuse is not operator replicable. If this fuse blows then the Seaward PV200/210 will indicate an error before the panel is shorted, the PV200/210 must be returned for service.

9.6 Service and Calibration.

To maintain the specified accuracy of the measurement results, the instrument must be recalibrated at regular intervals by either the manufacturer or an authorised Seaward Service Agent. We recommend a recalibration period of one year.

9.7 Spare Parts.

	Seaward Part No.
Test lead set	328A950
Carrying Case	388A951
500mA 1000V 1¼'	27B137

For help or advice on Service and Calibration contact:

Service Department
Seaward Electronic
Bracken Hill
South West Industrial Estate
Peterlee
Co Durham SR8 2SW
England

Tel: 0191 5878739 / 0191 5878737

Email: service@seaward.co.uk

Appendix A

IEC61557-2: Insulation		
Intrinsic error or influence quantity	Reference conditions or specified operating range	Designation code
Intrinsic error	Reference conditions	A
Position	Reference position $\pm 90^\circ$	E ₁
Supply voltage	At the limits stated by the manufacturer	E ₂
Temperature	0°C and 40°C	E ₃
Operating Error	$B = \pm(A/1.15 \sqrt{E_1^2 + E_2^2 + E_3^2})$	

IEC61557-4: Resistance of earth connection and equipotential bonding		
Intrinsic error or influence quantity	Reference conditions or specified operating range	Designation code
Intrinsic error	Reference conditions	A
Position	Reference position $\pm 90^\circ$	E ₁
Supply voltage	At the limits stated by the manufacturer	E ₂
Temperature	0°C and 40°C	E ₃
Operating Error	$B = \pm(A/1.15 \sqrt{E_1^2 + E_2^2 + E_3^2})$	